

# chouchou

by Lorenzo Zanovello  
STOOL



## STOOL. TABLE. SCULPTURE.

Whether stool or storage table, piece of column or inspired by the wrinkled folds of a curtain: in any case, chouchou is a sculptural eye-catcher; rose, blue or marble-coloured. Artist, sculptor and designer Lorenzo Zanovello has created a furniture from ceramics.

## YEAR OF DESIGN

2019

## MATERIAL

ceramic

## DIMENSIONS (mm)

350 L × 300 W × 430 H







## PRODUCT CHARACTERISTICS

Each piece is created from gloss glazed ceramic. Streaks and other variations in size and colour are part of the production process, and not defects of the design or production.

## ASSEMBLY REQUIRED

No.

## COLOURS + ART. NR

					
black 1701BGL	cobalt 1701CGL	marble white 1701MW	green 1701GRGL	rose 1701RGL	white 1701WGL

## COLOURS + ART. NR

		
tobacco 1701TO	sand 1701SA	silver 1701SI

## chouchou

### STOOL

350 L × 300 W × 430 H

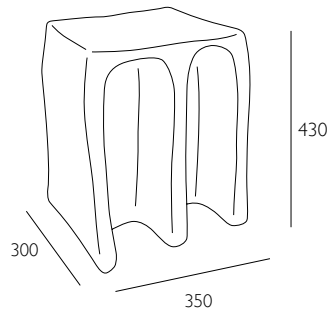

#### CARE INSTRUCTIONS

Regular cleaning and maintenance is important in order to keep your pulpo product looking its best and to prolong its life. Always remove any kind of dirt as soon as possible. We recommend that you first test a small, invisible area to ensure that no colour change or damage arises to the product. Do not use materials for maintenance that contain abrasive agents or are basic, acid or organic.

#### CERAMIC CLEANING

For dusting and light cleaning of ceramic, use a soft and dry cloth. For further cleaning, gently wipe the surface with a soft cloth wrung in clean warm water. Dry immediately afterwards with a soft, dry and clean cloth. For the best maintenance of the product, care for it regularly, and try to keep it away from moisture, grease and other dirt. Furthermore, protect the surfaces against sharp objects and others that might scratch.