

brut

by Ferréol Babin
SHELF



CLEAR OUTLINE. ROUGH EDGES. SOFT HEART.

Art Brut: Ferréol Babin's working method is often that of a sculptor. With brut, he even left the original boreholes in the massive marble. Deliberate breakage, paired with filigree glass, creates a hovering effect.

YEAR OF DESIGN

2020





MATERIAL

glass and marble

DIMENSIONS (mm)

800 L × 350 W × 1000 H

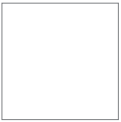
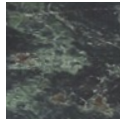
COLOURS + ART. NR

			
SHELF	parsol grey	satinato white	transparent
ART. NR	5702SH-PGR	5702SH-SW	5702SH-T
			
BOARDS	tauern green	krastal marble	dorfer green
ART. NR	5702PL-TG	5702PL-KRMA	5702PL-DG

PRODUCT CHARACTERISTICS

The shelves are produced from off-cut marble slabs with a raw cut front edge. The exterior of the shelves are created from sandblasted, smoked or proflit toughened glass. Bubbles, streaks and other variations in size and colour are part of the production process, and not defects of the design or production.

ASSEMBLY REQUIRED

Yes.

brut

800 L × 350 W × 1000 H

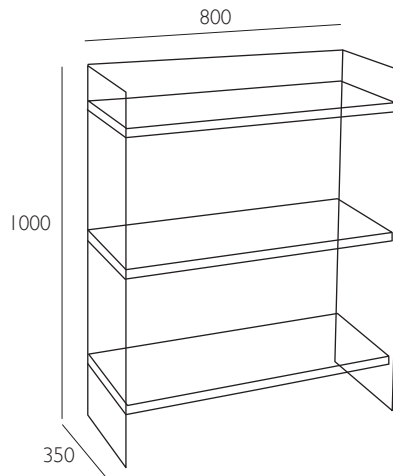

CARE INSTRUCTIONS

Regular cleaning and maintenance is important in order to keep your pulpo product looking its best and to prolong its life. Always remove any kind of dirt as soon as possible. We recommend that you first test a small, invisible area to ensure that no colour change or damage arises to the product. Do not use materials for maintenance that contain abrasive agents or are basic, acid or organic.

GLASS CLEANING

For dusting and light cleaning of glass use a soft, dry cloth. For further cleaning gently wipe the surface with a soft cloth wrung in clean water and a non-abrasive commercial glass cleaner. Dry immediately afterwards with a soft, dry and clean cloth. Please note that bubbles, streaks and other variations in size and colour are part of the production process, and not defects of the design or production of handmade glass.

MARBLE CLEANING

For dusting and light cleaning of stone use a soft, dry cloth. For further cleaning gently wipe the surface with a soft cloth wrung in clean warm water. Dry immediately afterwards with a soft, dry and clean cloth.