

# little monsters

by Vasilica Isăcescu & Nadja Zerunian  
CHAIRS



## CREEPY. WOODY. CRAFT.

Allow me, Fester, Gomez, Little Tully, Lumpy, Flora, Morticia and Eddy ... right, this lovely family of chairs is related to the notorious Addams Family. More than that, they stem from Transylvania. Master artisan Vasilica Isăcescu and Nadja Zerunian of co/rizom created these "Little Monsters". Their goal is rather innocent: To create authentic, fair and sustainable products from mother nature.

## COLOURS + ART. NR



COLOUR	eddy	fester	flora	gomez
black	6610B	6620B	6630B	6640B
rose	6610RO	6620RO	6630RO	6640RO



COLOUR	little tully	lumpy	morticia
black	6650B	6660B	6670B
rose	6650RO	6660RO	6670RO

## YEAR OF DESIGN

2022

## MATERIAL

wood

## DIMENSIONS (mm)

eddy	350 L × 390 W × 850 H
fester	390 L × 300 W × 900 H
flora	370 L × 270 W × 590 H
gomez	300 L × 300 W × 940 H
little tully	380 L × 360 W × 730 H
lumpy	350 L × 300 W × 770 H
morticia	300 L × 260 W × 950 H

## PRODUCT CHARACTERISTICS

Each piece is created from wood.

## ASSEMBLY REQUIRED

No.

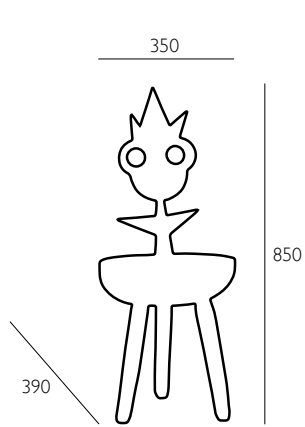

EDDY

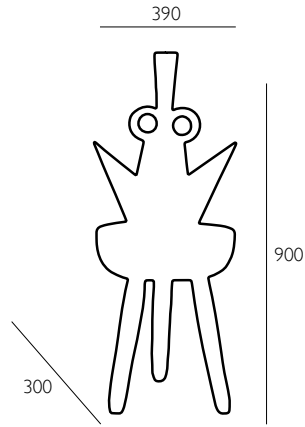

FESTER

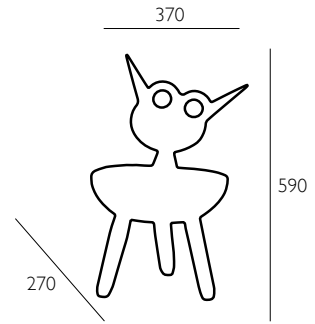

FLORA

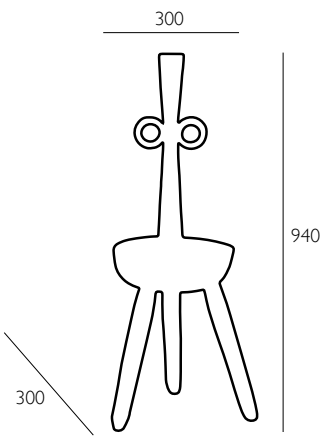

GOMEZ

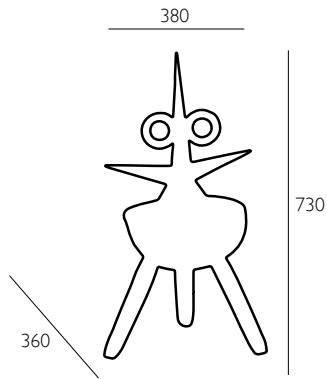

LITTLELULLY

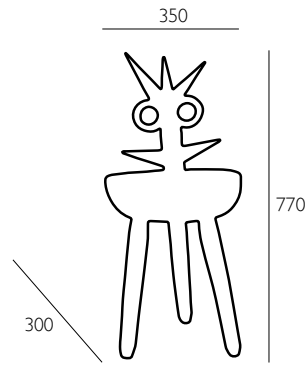

LUMPY

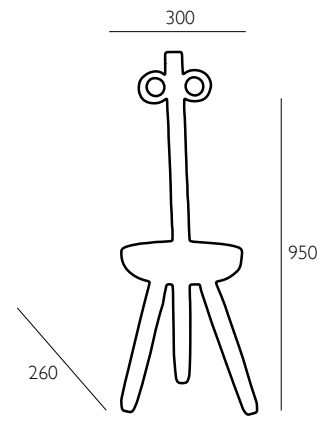

MORTICIA

### CARE INSTRUCTIONS

Regular cleaning and maintenance is important in order to keep your pulpo product looking its best and to prolong its life. Always remove any kind of dirt as soon as possible. We recommend that you first test a small, invisible area to ensure that no colour change or damage arises to the product. Do not use materials for maintenance that contain abrasive agents or are basic, acid or organic.

### WOOD CLEANING

Wipe down your wood furniture with a barely damp microfiber cloth to remove dust and grime. You never want water to sit on the wood, so quickly wipe it down with another dry microfiber cloth. For regular dusting, a quick wipe-down with a microfiber cloth will do the trick.